



McIntosh Laboratory, Inc. 2 Chambers Street Binghamton, New York 13903-2699 Phone: 607-723-3512 [www.mcintoshlabs.com](http://www.mcintoshlabs.com)

MC301

Quad Balanced  
Power Amplifier  
Owner's Manual



The lightning flash with arrowhead, within an equilateral triangle, is intended to alert the user to the presence of uninsulated “dangerous voltage” within the product’s enclosure that may be of sufficient magnitude to constitute a risk of electric shock to persons.

**WARNING - TO REDUCE RISK OF FIRE OR ELECTRICAL SHOCK, DO NOT EXPOSE THIS EQUIPMENT TO RAIN OR MOISTURE.**



**AVIS** RISQUE DE CHOC ELECTRIQUE - NE PAS OUVRIR.

**NO USER-SERVICEABLE PARTS INSIDE. REFER SERVICING TO QUALIFIED PERSONNEL.**

The exclamation point within an equilateral triangle is intended to alert the user to the presence of important operating and maintenance (servicing) instructions in the literature accompanying the appliance.

**To prevent the risk of electric shock, do not remove cover or back. No user-serviceable parts inside.**

## IMPORTANT SAFETY INSTRUCTIONS!

### PLEASE READ THEM BEFORE OPERATING THIS EQUIPMENT.

1. Read these instructions.
2. Keep these instructions.
3. Heed all warnings.
4. Follow all instructions.
5. Do not use this apparatus near water.
6. Clean only with a dry cloth.
7. Do not block any ventilation openings. Install in accordance with the manufacturer’s instructions.
8. Do not install near any heat sources such as radiators, heat registers, stoves, or other apparatus (including amplifiers) that produce heat.
9. Do not defeat the safety purpose of the polarized or grounding-type plug. A polarized plug has two blades with one wider than the other. A grounding type plug has two blades and a

third grounding prong. The wide blade or the third prong are provided for your safety. If the provided plug does not fit into your outlet, consult an electrician for replacement of the obsolete outlet.

10. Protect the power cord from being walked on or pinched particularly at plugs, convenience receptacles, and the point where they exit from the apparatus.
11. Only use attachments/accessories specified by the manufacturer.
12. Use only with the cart, stand, tripod, bracket, or table specified by the manufacturer, or sold with the apparatus. When a cart is used, use caution when moving the cart/apparatus combination to avoid injury from tip-over.
13. Unplug this apparatus during lightning storms or when unused for long periods of time.
14. Refer all servicing to qualified service personnel. Servicing is required when the apparatus has been damaged in any way, such as power-



supply cord or plug is damaged, liquid has been spilled or objects have fallen into the apparatus, the apparatus has been exposed to rain or moisture, does not operate normally, or has been dropped.

15. Do not expose this equipment to dripping or splashing and ensure that no objects filled with liquids, such as vases, are placed on the equipment.
16. To completely disconnect this equipment from the a.c. mains, disconnect the power supply cord plug from the a.c. receptacle.
17. The mains plug of the power supply cord shall remain readily operable.
18. Do not expose batteries to excessive heat such as sunshine, fire or the like.
19. Connect mains power supply cord only to a mains socket outlet with a protective earthing connection.

## Thank You

Your decision to own this McIntosh MC301 Quad Balanced Power Amplifier ranks you at the very top among discriminating music listeners. You now have “The Best.” The McIntosh dedication to “Quality,” is assurance that you will receive many years of musical enjoyment from this unit.

Please take a short time to read the information in this manual. We want you to be as familiar as possible with all the features and functions of your new McIntosh.

## Please Take A Moment

The serial number, purchase date and McIntosh Dealer name are important to you for possible insurance claim or future service. The spaces below have been provided for you to record that information:

Serial Number: \_\_\_\_\_

Purchase Date: \_\_\_\_\_

Dealer Name: \_\_\_\_\_

## Technical Assistance

If at any time you have questions about your McIntosh product, contact your McIntosh Dealer who is familiar with your McIntosh equipment and any other brands that may be part of your system. If you or your Dealer wish additional help concerning a suspected problem, you can receive technical assistance for all McIntosh products at:

McIntosh Laboratory, Inc.  
2 Chambers Street  
Binghamton, New York 13903  
Phone: 607-723-1545  
Fax: 607-724-0549

Copyright 2014 © by McIntosh Laboratory, Inc.

## Customer Service

If it is determined that your McIntosh product is in need of repair, you can return it to your Dealer. You can also return it to the McIntosh Laboratory Service Department. For assistance on factory repair return procedure, contact the McIntosh Service Department at:

McIntosh Laboratory, Inc.  
2 Chambers Street  
Binghamton, New York 13903  
Phone: 607-723-3515  
Fax: 607-723-1917

## Table of Contents

Safety Instructions .....	2
Thank You and Please Take a Moment.....	3
Technical Assistance and Customer Service .....	3
Table of Contents .....	3
General Information .....	3
Connector and Cable Information .....	4
Introduction.....	4
Performance Features .....	4
Dimensions .....	5
Installation .....	6
Rear Panel Connections and Switch .....	7
Output Terminals and How to Connect.....	8-9
Output Terminals and How to Connect for Bi-Amp .....	10-11
Front Panel Displays and Controls.....	12
How to Operate.....	13
Technical Description .....	14-17
Specifications.....	18
Packing Instruction.....	19

## General Information

1. For additional connection information, refer to the owner’s manual(s) for any component(s) connected to the MC301.

2. The MC301 mutes the speaker output for approximately two seconds when first turned on.
3. For the best performance and safety it is important to always match the impedance of the Loudspeaker to the Power Amplifier connections. Refer to “How to Connect” pages 8 thru 11.

*Note: The impedance of a Loudspeaker actually varies as the Loudspeaker reproduces different frequencies. As a result, the nominal impedance rating of the Loudspeaker (usually measured at a midrange frequency) might not always agree with the impedance of the Loudspeaker at low frequencies where the greatest amount of power is required. Contact the Loudspeaker Manufacturer for additional information about the actual impedance of the Loudspeaker before connecting it to the McIntosh MC301.*

4. In the event the MC301 over heats, due to improper ventilation and/or high ambient temperature, the protection circuits will activate. The Front Panel Power Guard LED will continuously indicate ON and the audio will be muted. When the MC301 has returned to a safe operating temperature, normal operation will resume.
5. When discarding the unit, comply with local rules or regulations. Batteries should never be thrown away or incinerated but disposed of in accordance with the local regulations concerning battery disposal.
6. For additional information on the MC301 and other McIntosh Products please visit the McIntosh Web Site at [www.mcintoshlabs.com](http://www.mcintoshlabs.com).





## Connector and Cable Information

### XLR Connectors

Below is the Pin configuration for the XLR Balanced Input, Input/Output Connectors on the MC301. Refer to the diagram for connection:

- PIN 1: Shield/Ground
- PIN 2: + Input/Output
- PIN 3: - Input/Output

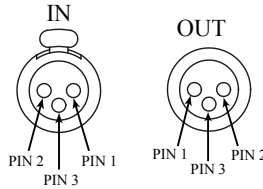

### Power Control Connector

The MC301 Power Control Input receives an On/Off signal from +5 to +12 volts. The Power Control Output will in turn provide a +12 volt Output Signal with a total current up to 50mA. An additional connection is for controlling the illumination of the MC301 Power Output Meters. The 3.5mm stereo mini phone plug connects to a McIntosh Preamplifier or A/V Control Center Power Control Output.

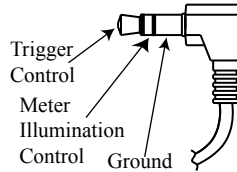

### Output Terminal Connector

When cables with spade lugs are used for Loudspeaker Connection, the spade lugs need an opening of at least 3/10 inch (7.6mm)

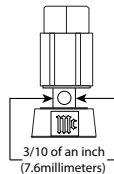

## Introduction

Now you can take advantage of traditional McIntosh standards of excellence in the MC301 Quad Balanced Power Amplifier. The 300 watts high current output will drive any high quality Loudspeaker. The MC301 reproduction is sonically transparent and absolutely accurate. The McIntosh Sound is “The Sound of the Music Itself.”

## Performance Features

### • Power Output

The MC301 is a Power Amplifier with a capability of 300 watts into 2, 4 or 8 ohm speakers with less than 0.005% distortion. The Power Amplifier Circuitry uses Thermal Trak<sup>1</sup> Output Transistors for lower distortion and cool operation.

### • Quad Balanced Circuitry

The MC301 is fully balanced from input to output. It consists of two matched power amplifiers operating in push-pull with their outputs combined in a McIntosh Autoformer. The Quad Balanced configuration cancels virtually all distortion.

### • Patented Autoformer

McIntosh designed and manufactured Output Autoformers provide an ideal match between the amplifier output stages and speaker loads of 2, 4 and 8 ohms. The Autoformers also provide perfect DC protection for your valuable loudspeakers.

### • Balanced and Unbalanced Inputs

Balanced connections guard against induced noise and allow long cable runs without compromising sound quality.

### • Power Guard

The patented McIntosh Power Guard circuit prevents the amplifier from being over driven into clipping, with its harsh distorted sound that can also damage your valuable loudspeaker.

### • Sentry Monitor and Thermal Protection

McIntosh Sentry Monitor power output stage protection circuits ensure the MC301 will have a long and

trouble free operating life. Built-in Thermal Protection Circuits guard against overheating.

### • Special Power Supply

A very large Power Transformer and Large Capacitors ensure stable noise free operation even though the power line varies.

### • Illuminated Power Meter

The Illuminated Power Output Watt Meter on the MC301 is peak responding, and indicates the true power output of the amplifier. The Front Panel Meter Illumination may be controlled On/Off by contemporary McIntosh Preamplifiers and Audio/Video Control Centers.

### • Auto Off

The MC301 incorporates a Power Save Feature to automatically switch power Off to the Power Amplifier approximately 30 minutes after there has been an absence of an audio input signal.

### • McIntosh Custom Binding Posts

McIntosh patent pending gold plated output terminals deliver high current output. They accept large diameter wire and spade lugs. Banana plugs may also be used only in the United States and Canada.

### • Glass Front Panel with Solid State Illumination

The famous McIntosh Illuminated Glass Front Panel is even Illuminated by the combination of custom designed Fiber Optic Light Diffusers and extra long life Light Emitting Diodes (LEDs).

<sup>1</sup>ThermalTrak™ and ON Semiconductor are trademarks of Semiconductor Components Industries, LLC

**Dimensions**

The following dimensions can assist in determining the best location for your MC301.

**Front View of the MC301**

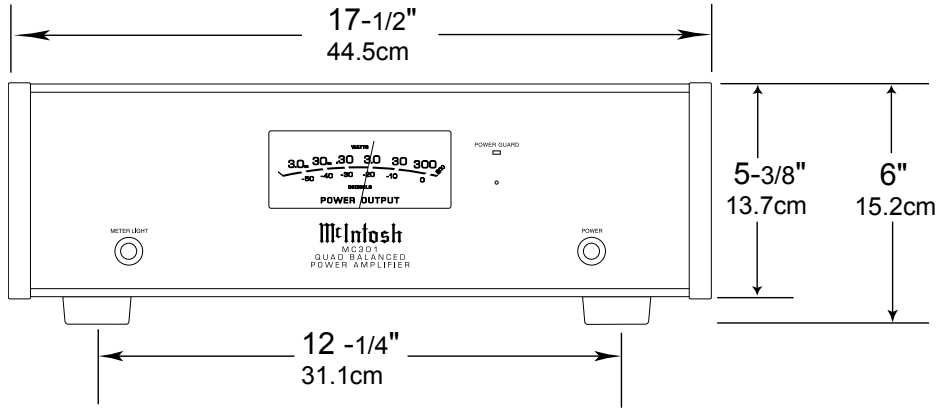

**Rear View of the MC301**

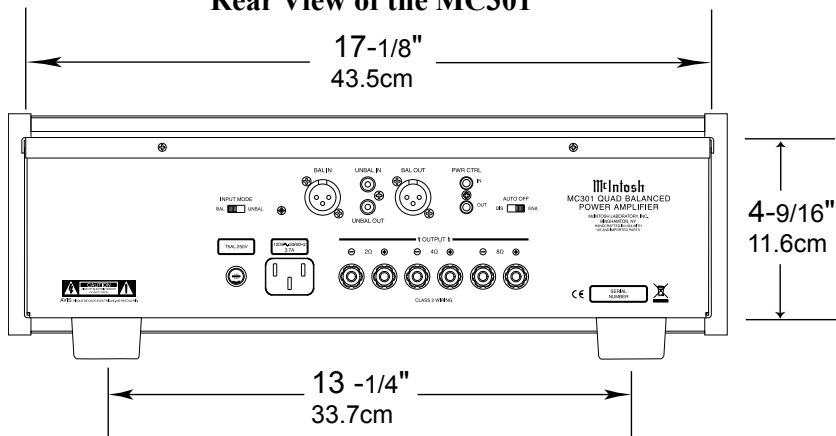

**Side View of the MC301**

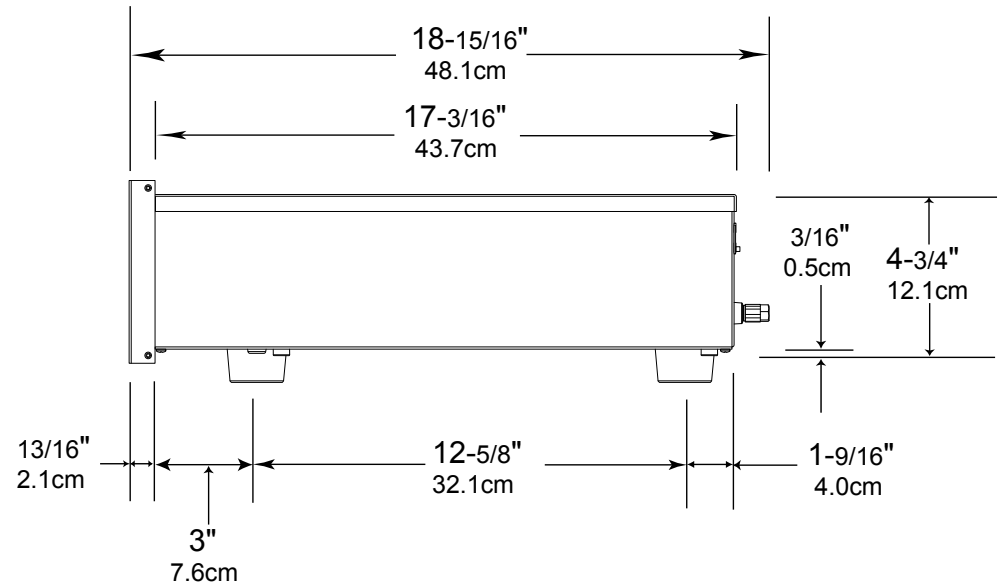

## Installation

The MC301 can be placed upright on a table or shelf, standing on its four feet. It also can be custom installed in a piece of furniture or cabinet of your choice. The four feet may be removed from the bottom of the MC301 when it is custom installed as outlined below. The four feet together with the mounting screws should be retained for possible future use if the MC301 is removed from the custom installation and used free standing. The required panel cutout, ventilation cutout and unit dimensions are shown.

Always provide adequate ventilation for your MC301. Cool operation ensures the longest possible operating life for any electronic instrument. Do not install the MC301 directly above a heat generating component such as a high powered amplifier. If all the components are installed in a single cabinet, a quiet running ventilation fan can be a definite asset in maintaining all the system components at the coolest possible operating temperature.

A custom cabinet installation should provide the following minimum spacing dimensions for cool operation.

Allow at least 6 inches (15.24cm) above the top, 2 inches (5.08cm) below the bottom, 3 inches (7.62cm) behind the rear panel and 2 inches (5.08cm) on each side of the Power Amplifier, so that airflow is not obstructed. Allow 2-1/2 inches (6.35 cm) in front of the mounting<sup>1</sup> panel for clearance. **Be sure to cut out a ventilation hole in the mounting shelf according to the dimensions in the drawing.**

<sup>1</sup> When the MC301 is installed together with other McIntosh Components, check clearances on all components before proceeding.

MC301 Front Panel  
Custom Cabinet Cutout

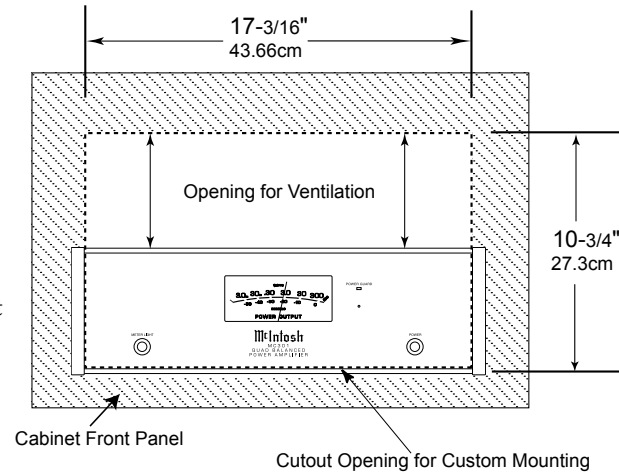

MC301 Side View  
in Custom Cabinet

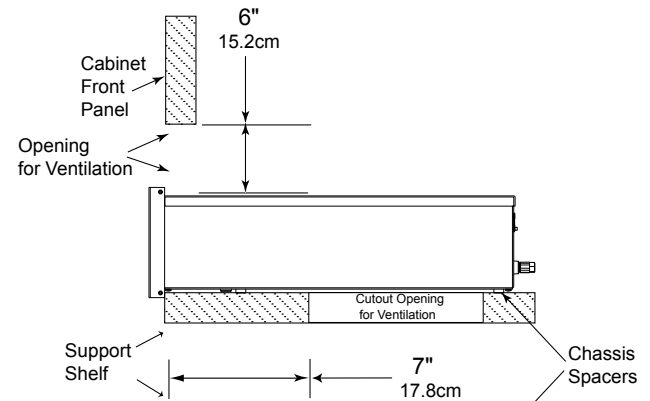

MC301 Bottom View  
in Custom Cabinet

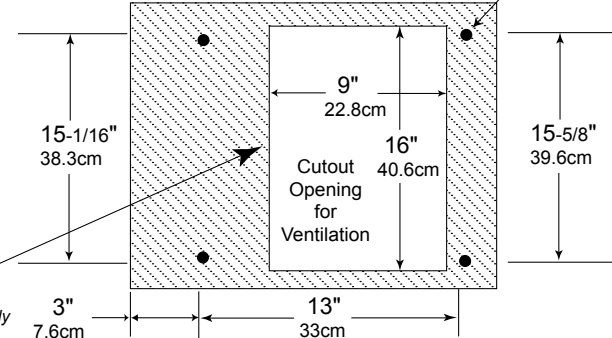

Note: Center the cutout horizontally on the unit. For purposes of clarity, the above illustration is not drawn to scale.

# Rear Panel Connections and Switch

INPUT MODE switch selects between UNBALanced or BALanced Input

UNBALanced INput for an audio cable from a Preamplifier or A/V Control Center audio output

BALanced OUTput for an audio cable to the next Power Amplifier Input

AUTO OFF Power Save Feature is either DISabled or ENabled

BALanced INput for audio cables from a Preamplifier or A/V Control Center audio output

UNBALanced OUTput for an audio cable to the next Power Amplifier Input

PoWeR ConTRoL IN receives turn On/Off signals from a McIntosh component

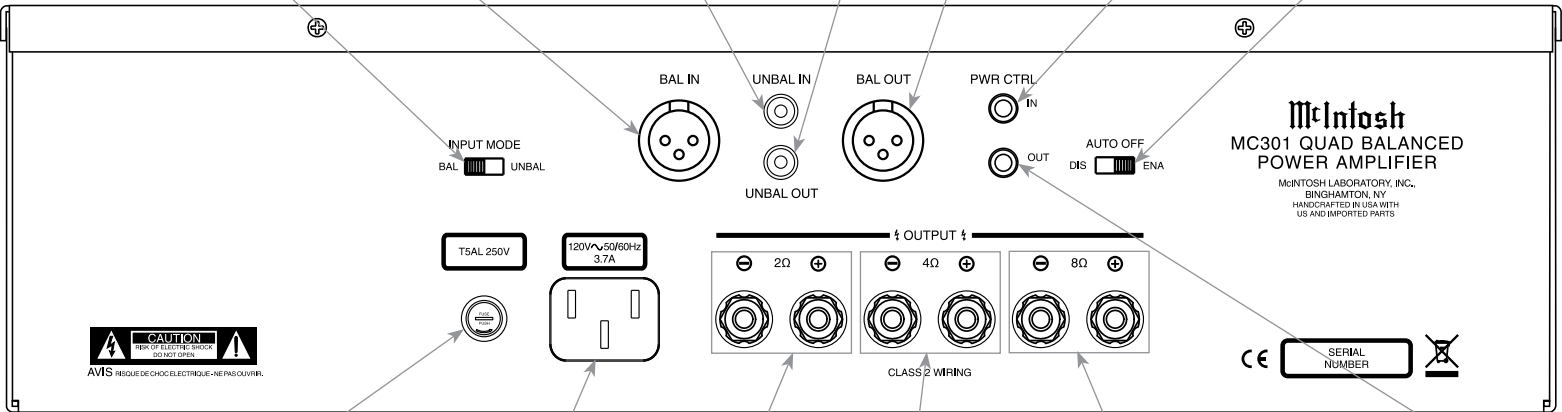

Fuse holder, refer to information on the rear panel of your MC301 to determine the correct fuse size and rating

Connect the MC301 power cord to a live AC outlet. Refer to the rear panel to determine the correct voltage

OUTPUT Connections for a 2 ohm Loudspeaker

OUTPUT Connections for a 4 ohm Loudspeaker

OUTPUT Connections for a 8 ohm Loudspeaker

PoWeR ConTRoL OUT sends turn On/Off signals to the next McIntosh Component

**Caution:** The Loudspeaker ⊖ Negative Connections are above chassis ground. Do not combine any connections together, ground them or connect with another MC301.



## Output Terminals

When connecting the Loudspeaker Hookup Cables to the MC301 Power Amplifier Output Terminals please follow the steps below:

1. Rotate the top of the Output Terminal Post counterclockwise until an opening appears. Refer to figures A and B.
2. Insert the Loudspeaker hookup cable into the Output Terminal Post opening or the cable spade lug around the center post of the Output Terminal. Refer to figure C.
3. Rotate the top of the Output Terminal Post clockwise until it is finger tight. Refer to figure D.
4. Place the supplied McIntosh Wrench over the top of the Output Terminal and rotate it one quarter of a turn (90°) to secure the Loudspeaker Cable Connection. **Do not over tighten.** Refer to figure E.

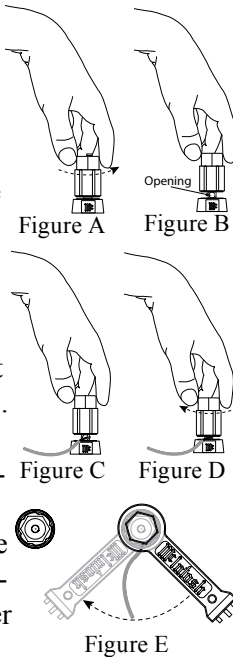

## How to Connect

**Caution: Do not connect the AC Power Cord to the MC301 Rear Panel until after the Loudspeaker Connections are made. Failure to observe this could result in Electric Shock.**

The connection instructions below, together with the MC301 Connection Diagram located on the separate folded sheet “Mc1A”, is an example of a typical audio system. Your system may vary from this, however the actual components would be connected in a similar manner. For additional information refer to “Connector and Cable Information” on page 4.

1. For Remote Power Control, connect a power control cable from the Audio Preamplifier or A/V Control Center Power Control Output 1 to the Amplifier PoWeR ConTRoL IN.

*Note: When a Power Control Cable is connected between the MC301 and Preamplifier (or A/V Control Center), the AUTO OFF Feature is bypassed. Refer to page 13.*

2. Connect XLR cables from the Balanced Output 1 (R, refer to note 2 below) of an Audio Preamplifier or A/V Control Center to the Amplifier BALANCED INput. Place the INPUT MODE Switch in the BALANCED Position.

*Notes: 1. An optional hookup is to use unbalanced cable and place the INPUT MODE Switch in the UNBALANCED Position.*

2. *When multiple MC301s are used in a Stereo or Multichannel System, match up the Preamplifier or A/V Control Center Channel Output designation to each MC301 with Loudspeaker and the Loudspeaker location in the room.*

This McIntosh MC301 Quad Balanced Power Amplifier is designed for Loudspeakers with an impedance of 2 ohms, 4 ohms or 8 ohms. Connect a single Loudspeaker only to the Output Terminals.

When connecting Loudspeakers to the MC301 it is very important to use cables of adequate size, so there is little to no power loss in the cables. The size is specified in Gauge Numbers or AWG (American Wire Gauge). The smaller the Gauge number, the larger the wire size:

Loudspeaker Cable Distance vs Wire Gauge Guide			
Loudspeaker Impedance	25 feet (7.62 meters) or less	50 feet (15.24 meters) or less	100 feet (30.48 meters) or less
2 Ohms	12AWG	10AWG	8AWG
4 Ohms	14AWG	12AWG	10AWG
8 Ohms	16AWG	14AWG	12AWG

3. Prepare the Loudspeaker Hookup Cable for attachment to the MC301 Power Amplifier:

### Bare wire cable ends:

Carefully remove sufficient insulation from the cable ends, refer to figures 2, 3 & 4. If the cable is stranded, carefully twist the strands together as tightly as possible.

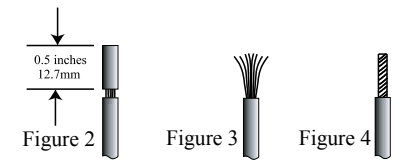

- Notes: 1. If desired, the twisted ends can be tinned with solder to keep the strands together.*
2. *The prepared bare wire cable ends may be inserted into spade lug connectors.*
  3. *Banana plugs are for use in the United States and Canada only.*

### **Banana Plugs are for use in the United States and Canada only:**

4. Attach the previously prepared bare wire cable ends into the banana plugs and secure the connections. Refer to figure F.
5. Rotate the top of the Output Terminal Post clockwise until it is finger tight. Refer to figure G. Then using the McIntosh Wrench, rotate the top of the Output Terminal

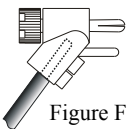



one quarter of a turn (90°). **Do not over tighten.** Refer to figure E.

- Referring to figure H, connect the Loudspeaker hookup cables with banana plugs into the hole at the top of the MC301 Negative and Positive Output Terminals. The terminals are indentified as 2Ω (ohms), 4Ω (ohms) or 8Ω (ohms) connection to match the impedance of the Loudspeaker, being careful to observe the correct polarities.

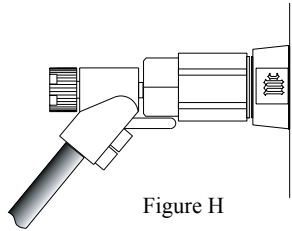

Figure H

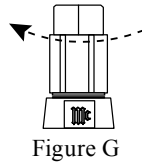

Figure G

lug connector or prepared section of the cable end into the terminal side access hole, and tighten the terminal cap until the cable is firmly clamped into the terminals so the lugs or wire cannot slip out. Refer to figures 7 and 8.

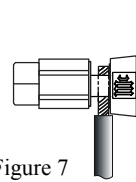

Figure 7

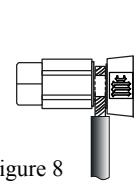

Figure 8

*Note: The illustration on separate sheet "McIA" is connections for 8Ω (ohms) Loudspeakers.*

If the Loudspeaker's impedance is in-between the available connections, use the nearest lower impedance connection. Refer to "General Information" Note 3 on page 3 for additional information.

**WARNING: Loudspeaker terminals are hazardous live and present a risk of electric shock. For additional instruction on making Loudspeaker Connections contact your McIntosh Dealer or McIntosh Technical Support.**

*Note: The illustration on separate sheet "McIA" is connections for 8Ω (ohms) Loudspeakers.*  
If the Loudspeaker's impedance is in-between the available connections, use the nearest lower impedance connection. Refer to "General Information" Note 3 on page 3 for additional information.

**WARNING: Loudspeaker terminals are hazardous live and present a risk of electric shock. For additional instruction on making Loudspeaker Connections contact your McIntosh Dealer or McIntosh Technical Support.**

- Connect the MC301 power cord to an active AC outlet.

**Spade Lug or Wire Connections:**

- Connect the Loudspeaker hookup cables to the MC301 Negative Output Terminal and Positive Output Terminal indentified as 2Ω (ohms), 4Ω (ohms) or 8Ω (ohms) connection to match the impedance of the Loudspeaker, being careful to observe the correct polarities. Insert the spade





## Output Terminals

When connecting the Loudspeaker Hookup Cables to the MC301 Power Amplifier Output Terminals please follow the steps below:

1. Rotate the top of the Output Terminal Post counterclockwise until an opening appears. Refer to figures A and B.

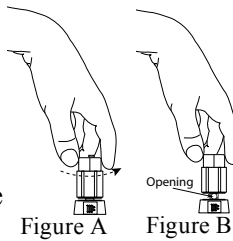

2. Insert the Loudspeaker hookup cable into the Output Terminal Post opening or the cable spade lug around the center post of the Output Terminal. Refer to figure C.

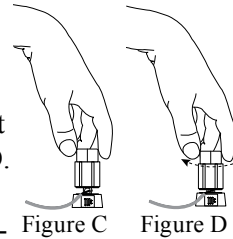

3. Rotate the top of the Output Terminal Post clockwise until it is finger tight. Refer to figure D.

4. Place the supplied McIntosh Wrench over the top of the Output Terminal and rotate it one quarter of a turn (90°) to secure the Loudspeaker Cable Connection. **Do not over tighten.** Refer to figure E.

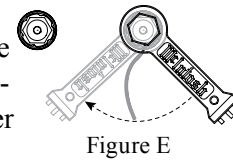

## How to Connect for Bi-Amp

**Caution:** Do not connect the AC Power Cord to the MC301 Rear Panel until after the Loudspeaker Connections are made. Failure to observe this could result in Electric Shock.

The connection instructions below, together with the MC301 Connection Diagram located on the separate folded sheet “Mc1B”, is an example of a typical audio system. Your system may vary from this, however the actual components would be connected in a similar manner. For additional information refer to “Connector and Cable Information” on page 4.

1. For Remote Power Control, connect a power control cable from the Audio Preamplifier or A/V Control Center Power Control Output 1 to Amplifier One PoWeR CoNTRoL IN.

*Note: When the Power Control Cable is connected between the MC301 and Preamplifier or A/V Control Center, the AUTO OFF Power Save Feature is automatically disabled.*

2. Connect a power control cable from Amplifier One PoWeR CoNTRoL OUTput 1 to Amplifier Two PoWeR CoNTRoL IN.
3. Connect XLR cables from the Balanced Output 1 (R, refer to note 2 below) of an Audio Preamplifier or A/V Control Center to Amplifier BALANCED INput. Place the INPUT MODE Switch in the BALANCED Position.

*Notes: 1. An optional hookup is to use unbalanced cable and place the INPUT MODE Switch in the UNBALANCED Position.*

*2. When multiple MC301s are used in a Stereo or Multichannel System, match up the Preamplifier or A/V Control Center Channel Output designation to each MC301 with Loudspeaker and the Loudspeaker location in the room.*

4. Connect XLR cables from Amplifier One Audio BALANCED OUTput to Amplifier Two BALANCED INput.

This McIntosh MC301 Quad Balanced Power Amplifier is designed for Loudspeakers with an impedance of 2 ohms, 4 ohms or 8 ohms. Connect a single Loudspeaker only to the Output Terminals.

When connecting Loudspeakers to the MC301 it is very important to use cables of adequate size, so there is little to no power loss in the cables. The size is specified in Gauge Numbers or AWG (American Wire Gauge). The smaller the Gauge number, the larger the wire size:

Loudspeaker Cable Distance vs Wire Gauge Guide			
Loudspeaker Impedance	25 feet (7.62 meters) or less	50 feet (15.24 meters) or less	100 feet (30.48 meters) or less
2 Ohms	12AWG	10AWG	8AWG
4 Ohms	14AWG	12AWG	10AWG
8 Ohms	16AWG	14AWG	12AWG

5. Prepare the Loudspeaker Hookup Cable for attachment to the MC301 Power Amplifier:

Bare wire cable ends:

Carefully remove sufficient insulation from the cable ends, refer to figures 2, 3 & 4. If the cable is stranded, carefully twist the strands together as tightly as possible.

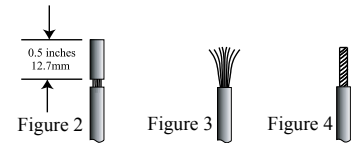

- Notes: 1. If desired, the twisted ends can be tinned with solder to keep the strands together.*
2. The prepared bare wire cable ends may be inserted into spade lug connectors.
  3. Banana plugs are for use in the United States and Canada only.

**Banana Plugs are for use in the United States and Canada only:**

6. Attach the previously prepared bare wire cable ends into the banana plugs and secure the connections. Refer to figure F.

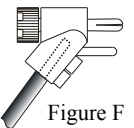

7. Rotate the top of the Output Terminal Post clockwise until it is finger tight. Refer to figure G. Then using the McIntosh Wrench, rotate the top of the Output Terminal one quarter of a turn (90°). **Do not over tighten.** Refer to figure E.

8. Referring to figure H, connect the Loudspeaker hookup cables with banana plugs into the hole at the top of the MC301 Negative and Positive Output Terminals. The terminals are identified as 2Ω (ohms), 4Ω (ohms) or 8Ω (ohms) connection to match the impedance of the Loudspeaker, being careful to observe the correct polarities.

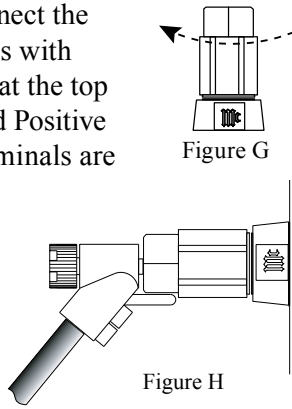

*Note: The illustration on separate sheet "McIB" is connections for 8Ω (ohms) Loudspeakers.*  
 If the Loudspeaker's impedance is in-between the available connections, use the nearest lower impedance connection. Refer to "General Information" Note 3 on page 3 for additional information.

**WARNING: Loudspeaker terminals are hazardous live and present a risk of electric shock. For additional instruction on making Loudspeaker Connections contact your McIntosh Dealer or McIntosh Technical Support.**

9. Connect the MC301 power cord to an active AC outlet.

**Spade Lug or Wire Connections:**

10. Connect the Loudspeaker hookup cables to the MC301 Negative Output Terminal and Positive Output Terminal identified as 2Ω (ohms), 4Ω (ohms) or 8Ω (ohms) connection to match the impedance of the Loudspeaker, being careful to observe the correct polarities. Insert the spade lug connector or prepared section of the cable end into the terminal side access hole, and tighten the

terminal cap until the cable is firmly clamped into the terminals so the lugs or wire cannot slip out. Refer to figures 7 and 8.

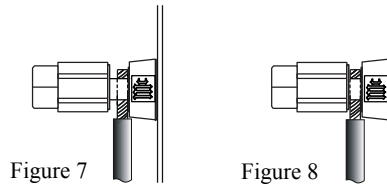

*Note: The illustration on separate sheet "McIB" is connections for 8Ω (ohms) Loudspeakers.*

If the Loudspeaker's impedance is in-between the available connections, use the nearest lower impedance connection. Refer to "General Information" Note 3 on page 3 for additional information.

**WARNING: Loudspeaker terminals are hazardous live and present a risk of electric shock. For additional instruction on making Loudspeaker Connections contact your McIntosh Dealer or McIntosh Technical Support.**

11. Connect the MC301 power cord to an active AC outlet.



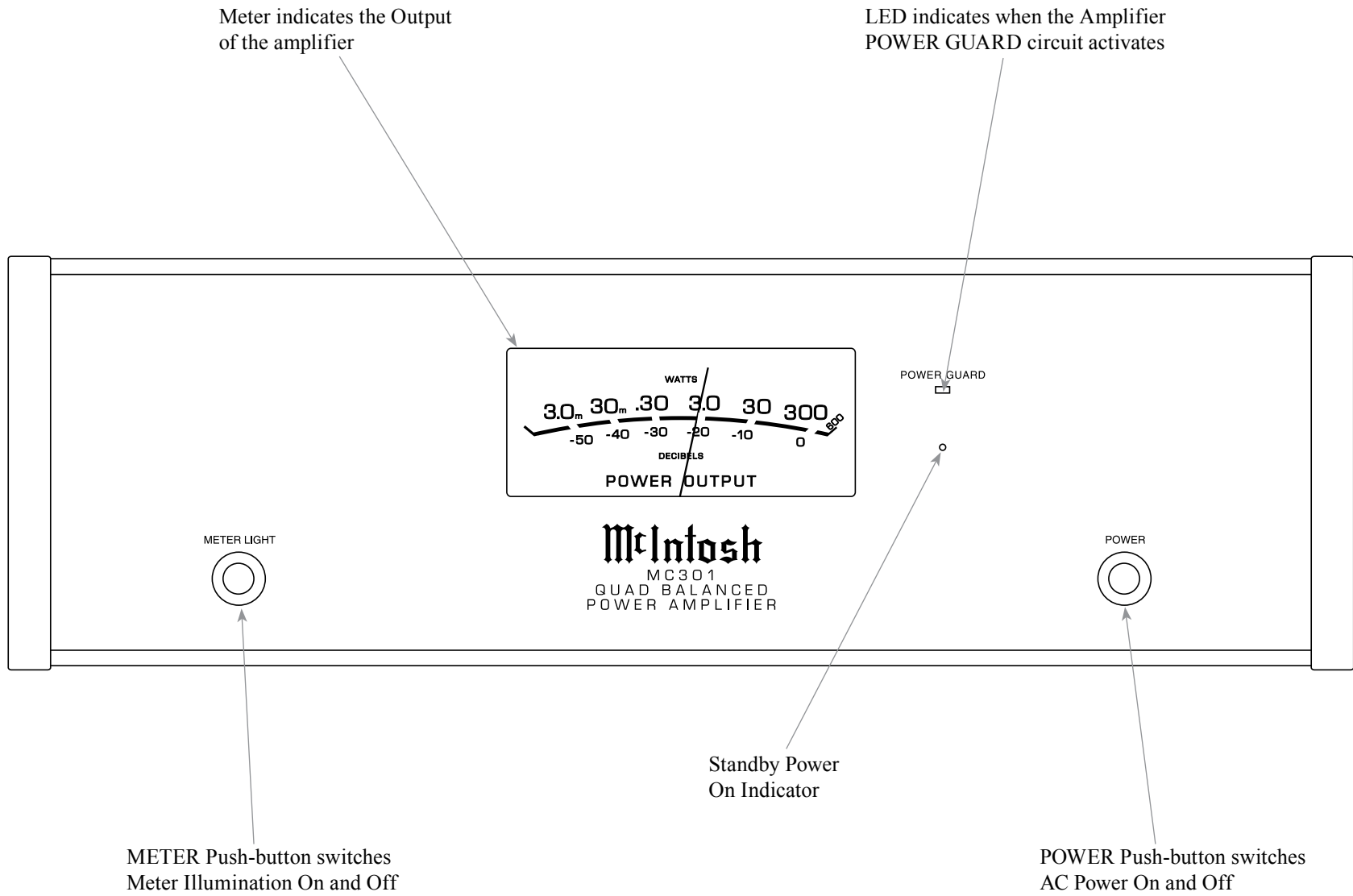

## How to Operate

### Power On/Off

Momentarily press the POWER Push-button to switch the MC301 On or Off. Refer to figure 8.

*Note: There must be a power control connection between the MC301 and the Audio Preamplifier or A/V Control Center, in order for the remote power turn-on to function.*



Figure 8

### Auto Off

The MC301 incorporates a Power Save Feature to automatically switch power Off to the Power Amplifier approximately 30 minutes after there has been an absence of an audio input signal.

*Note: If the Power Save Feature has activated and switched the MC301 Off, the Power Save Feature can be reset by momentarily pressing the POWER Push-button.*

When there is a Power Control Connection between the MC301 and a McIntosh Preamplifier or (A/V Control Center), the Power Save Feature in the MC301 is bypassed.

With the MC301 connected (via Power Control) to a McIntosh Preamplifier (or A/V Control Center) with the Power Save Feature and the feature is active, the MC301 will switch Off with the Preamplifier (or A/V Control Center) after a period of inactivity.

There may be times when it would be desirable to bypass the Power Save Feature, which by default is active. This can be implemented by placing the “AUTO OFF” Switch, located on the MC301 Rear Panel, in the DIS (Disable) position.

Refer to figure 9:



Figure 9

### Power Meter

By default the Power Output Meter is illuminated when the MC301 is On. To switch Off the Meter Illumination, momentarily press the METER LIGHT Push-button. Refer to figure 10. The Power Output Meter will continue to indicate the power output even with the Illumination Off.

*Note: When Power Control Input of the MC301 is connected to an Audio Preamplifier or A/V Control Center with Remote Meter Illumination Control, the Meter Illumination will automatically be remotely controlled (On/Off).*

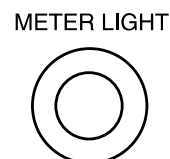

Figure 10

The meter responds to all the musical information being produced by the amplifier. It indicates to an accuracy of at least 95% of the power output with only a single cycle of a 2000Hz tone burst. Refer to figure 11.

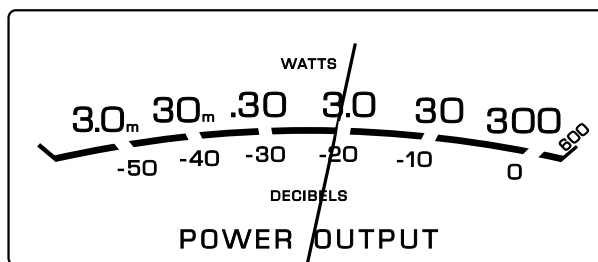

Figure 11

### Input Mode Switch

The Input Mode Switch, which is located on the Rear Panel of the MC301, allows selection of either the BALanced or UNBALanced Input. Refer to figure 12.

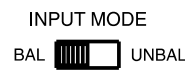

Figure 12



## Technical Description

McIntosh Laboratory, the company who introduced the world's first amplifier that could be called "High Fidelity", has done it again. The McIntosh engineering staff has created a power amplifier without compromise, using the most advanced McIntosh circuit design concepts.

The MC301 has a continuous average power output rating of 300 watts and with a peak output current of 60 amperes; making this one of the most advanced amplifiers available today. The distortion limits for the MC301 are no more than 0.005% at rated power output for all frequencies from 20Hz to 20,000Hz.

Typical performance at mid frequencies is less than 0.002%. The true distortion readings on the MC301 are so low, it takes special measuring techniques to make accurate readings. The MC301 can deliver the best possible performance from any type of high quality loudspeaker system. Refer to figure 13.

Creating an amplifier with this level of performance did not come easily. Many months of design, testing and measuring were required. Extensive controlled listening tests, the ultimate form of measuring, were made before the final design was accepted.

### Design Philosophy

The design philosophy incorporated in the MC301 involved several different techniques, all based on sound scientific logic. Every stage of voltage or current amplification must be as linear as possible prior to the use of negative feedback. McIntosh engineers know how to properly

design negative feedback circuits so they contribute to the extremely low distortion performance expected from a McIntosh amplifier. The typical McIntosh owner would never accept the approximately 100 times higher distortion of many non-feedback designs. Refer to figure 14

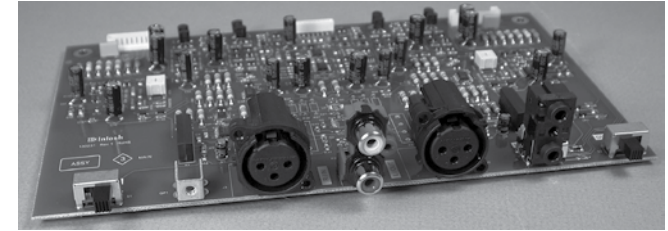

Figure 14

Double Balanced Push-Pull design is used from input to output. Each half of the amplifier contains complimentary balanced circuitry. The resulting Quad Balanced configuration cancels even order distortion. Refer to figure 15.

All transistors are selected to have nearly constant current gain over the entire current range they must cover. Output transistors in particular, have matched uniform current gain, high current bandwidth product and large active region safe operating area. These Power Transistors are the very latest in semiconductor technology and incorporate a new design known as ThermalTrak™. Refer to figure 16. This allows for the instantaneous and accurate monitoring of the Power Transistor Temperature. The MC301 Power Output Circuitry has a specially designed bias circuit to take full advantage of the ThermalTrak™ Power Transistors and thus precisely controls the power amplifier operation over a wide range of music



Figure 16

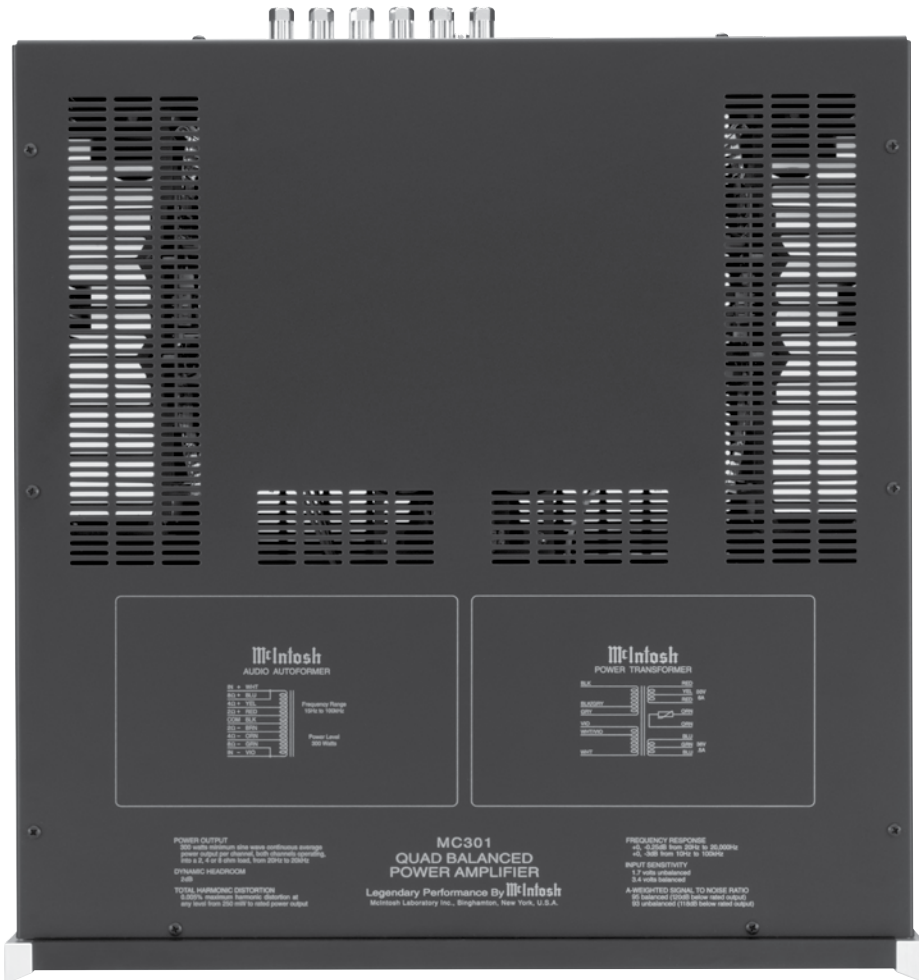

Figure 13

conditions with the benefits of lower distortion and cooler operation. Precision metal film resistors and low dielectric absorption film capacitors are used in all critical circuit locations.

The output signals of the two balanced circuits are coupled together in the unique McIntosh MC301 Output Autoformer. It provides low distortion power transfer at frequencies from below 20Hz to well beyond 20,000Hz with optimum impedance points of two ohms, four ohms and eight ohms. The unequalled expertise of McIntosh in the design and manufacturing of autoformers is legendary in the high fidelity industry.

The high efficiency circuit design of the MC301 contributes to low operating temperatures. More than 800 square inches of heat sink area keep the MC301 operating safely with convection cooling. No fans

are needed. Refer to figure 17.

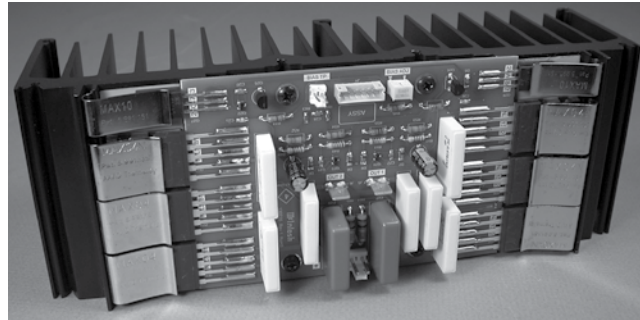

Figure 17

**Autoformers**

All solid state power amplifier output circuits work best into what is called an optimum load. This optimum load may vary considerably from what a loudspeaker requires. In the case of more than one

loudspeaker connected in parallel, the load to the power amplifier may drop to two ohms or even less. A power amplifier connected to a load that is lower than optimum, causes more output current to flow, which results in extra heat being generated in the power output stage. This increase in temperature will result in a reduced life expectancy for the amplifier.

The special Balanced Winding Autoformer creates an ideal match between the power amplifier output stage and the loudspeaker. Refer to figure 18.

There is absolutely no performance limitation with an Autoformer. Its frequency response exceeds that of the output circuit itself, and extends well beyond the audible range. Its distortion level is so low it is virtually impossible to measure.



Figure 18

Its distortion level is so low it is virtually impossible to measure.

In the rare event of a power amplifier output circuit failure, the McIntosh Autoformer provides absolute protection from possible damage to your valuable loudspeakers. The unequalled expertise of McIntosh in the design and manufacturing of Autoformers is legendary in the high fidelity industry. McIntosh engineers know how to do it right.

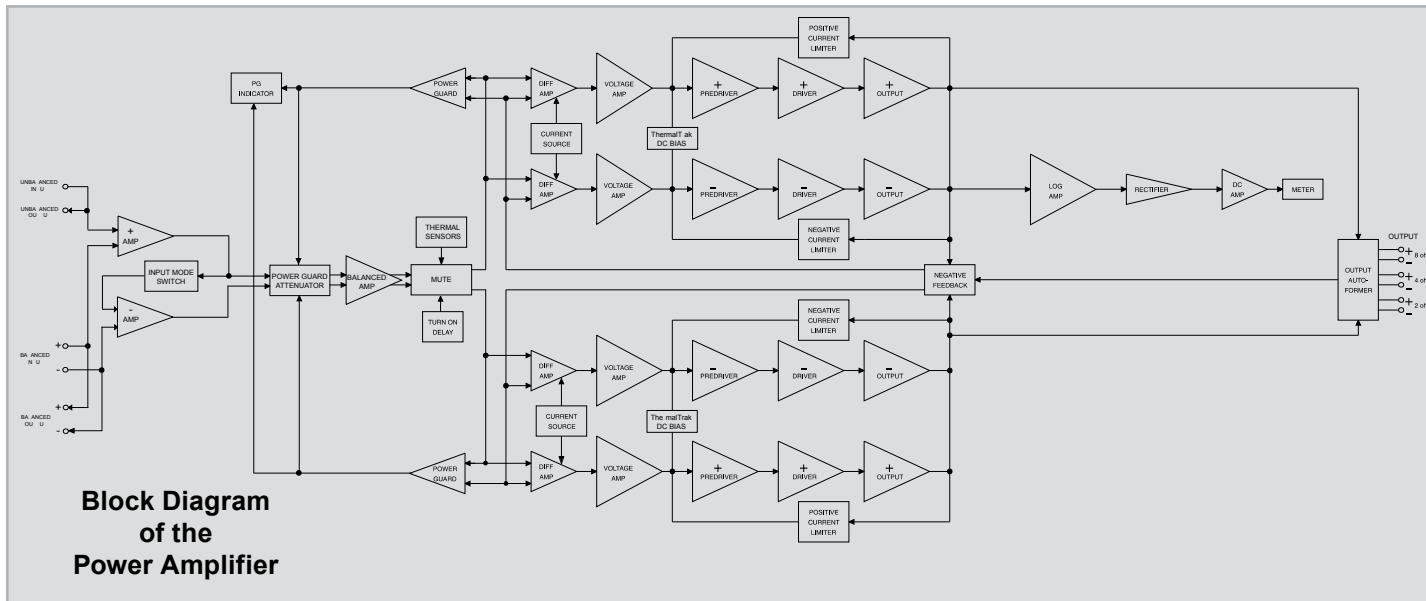

**Block Diagram of the Power Amplifier**

Figure 15

## Technical Description, con't

### Power Output Meter

The McIntosh MC301 has a large Output Watt Meter that responds 95% full scale to a single cycle tone burst at 2kHz. Refer to figure 19.

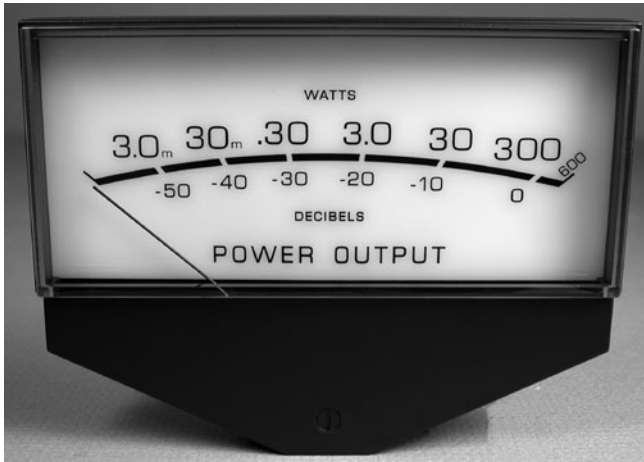

Figure 19

Voltage output is electronically measured, multiplied and fed to a special circuit that accelerates the pointer movement in the upward direction. Refer to figure 14 on the previous page. When the pointer reaches its peak it pauses only long enough for the human eye to perceive its position, then drops. It is almost 10 times faster than a professional VU meter.

### Protection Circuits

The MC301 incorporates the McIntosh Sentry Monitor Output Transistor Protection Circuit. Refer to Figure 20. There is absolutely no compromise in sonic performance with this circuit, and it ensures safe operation of the amplifier under even the most extreme operating conditions. The different types of protection circuits incorporated in the MC301 insure a long and safe operating life. This is just one of the many characteristics of McIntosh Power Amplifiers that make them world famous.

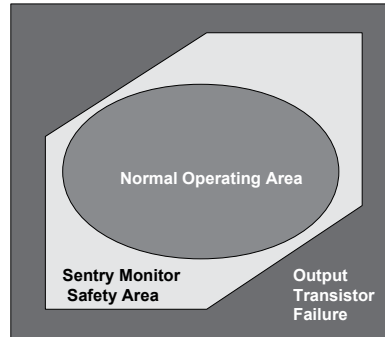

Figure 20

The MC301 also includes the unique patented McIntosh Power Guard circuit. Power Guard eliminates the possibility of ever overdriving the amplifier into clipping. Refer to figures 21, 22 and 23.

An overdriven amplifier can produce both audible and inaudible distortion levels exceeding 40%. The audible distortion is unpleasant to hear, but the inaudible ultrasonic distortion is also undesirable, since it can damage valuable loudspeaker system tweeters. You will never experience the

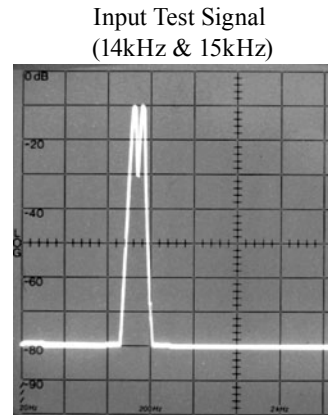

Figure 21

harsh and damaging distortion due to clipping.

The Power Guard circuit is a waveform comparator, monitoring both the input and output waveforms. Under normal operating conditions, there are no differences between the shape of these waveforms. If the amplifier is overdriven, there will be a difference between the two signal waveforms. When the difference exceeds 0.3%, the Power Guard activates the PG light and a dynamic electronic attenuator at the amplifier input reduces the input volume just enough to prevent any further increase in distortion.

The Power Guard circuit acts so fast that there are absolutely no audible side effects and the sonic purity of the music reproduction is perfectly preserved. The MC301 Power Amplifier with Power Guard is not limited to just the rated power output, but will actually produce distortion free output well above its rated power due to the McIntosh philosophy of conservative design.

Without Power Guard

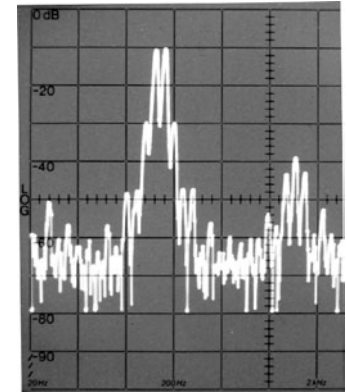

Figure 22

With Power Guard

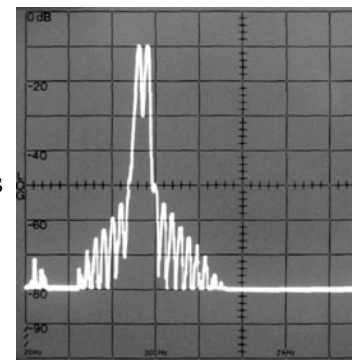

Figure 23



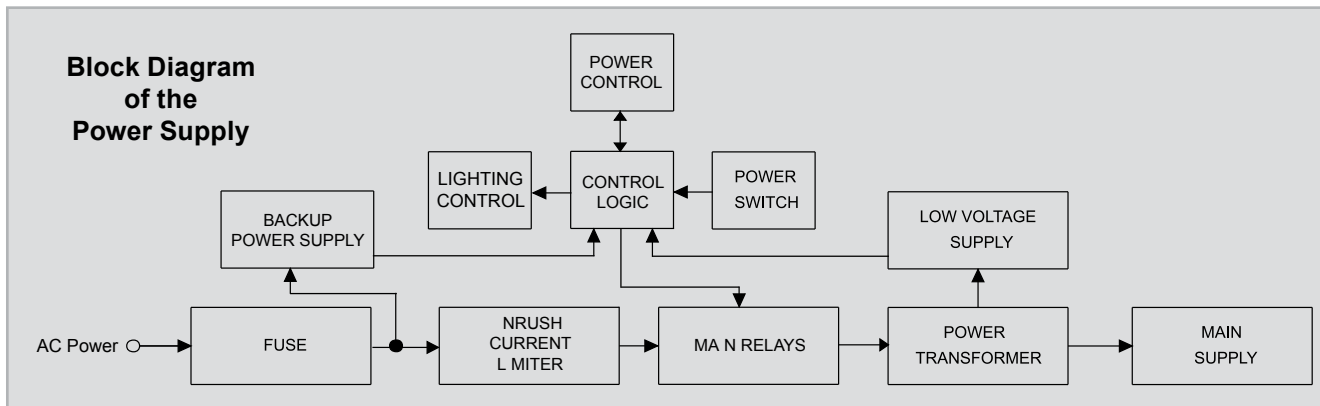

Figure 24

**Power Supply Circuits**

To compliment the design of the MC301 Power Amplifier Circuitry, there is a high current high voltage power supply. Refer to figures 24 and 26. The very large Power Transformer can supply over 6 amps of current. Refer to figure 25 (golf ball is for size comparison). It is enclosed in the legendary McIntosh Potted Enclosures and weighs 18 lbs.

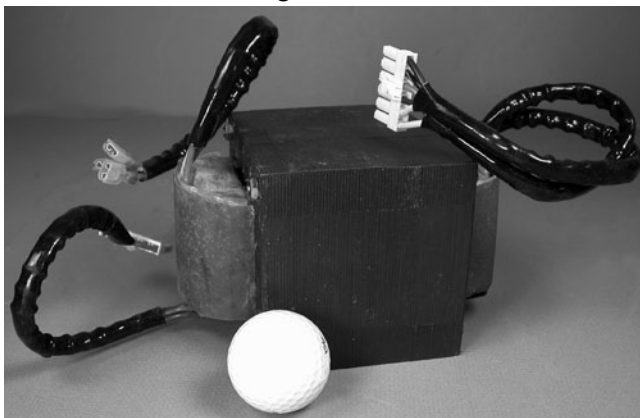

Figure 25

There are two super size main filter capacitors supplying all of the energy which is necessary for the wide dynamic range that "Digital Audio" demands. Refer to figure 26.

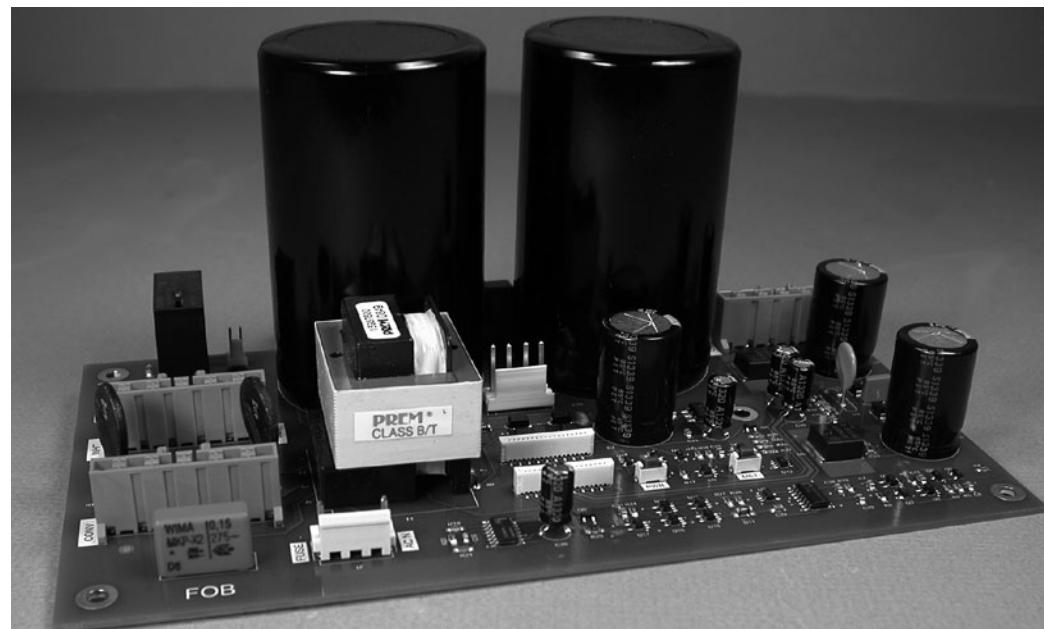

Figure 26

The power amplifier draws high current from the AC power line. Therefore, it is important that they plug directly into the wall outlet.

Also, most owners desire one power switch for the whole audio system. The MC301 is equipped with a circuit that provides remote Power Control from a McIntosh A/V Control Center. Refer to figure 14 on page 14. When the A/V Control Center is switched On, a (5-12V) signal operates the power relay in the MC301. The MC301 also has a Power Control Out Jack. The Power Control signal from this jack is delayed by a fraction of a second so that the turn on power surge of the next power amplifier occurs at a later time. This helps prevent power circuit overload that could trip circuit breakers or blow fuses, a very important feature in a high power Home Systems employing multiple MC301 Power Amplifiers.



## Specifications

### Power Output

Minimum sine wave continuous average power output is:

- 300 watts into 2 ohm load
- 300 watts into 4 ohm load
- 300 watts into 8 ohm load

### Output Load Impedance

2, 4 or 8 ohms

### Rated Power Band

20Hz to 20,000Hz

### Total Harmonic Distortion

0.005% maximum harmonic distortion at any power level from 250 milliwatts to rated power, 20Hz to 20,000Hz

### Dynamic Headroom

2dB

### Frequency Response

- +0, -0.25dB from 20Hz to 20,000Hz
- +0, -3.0dB from 10Hz to 100,000Hz

### Input Sensitivity (for rated output)

- 3.4 Volts Balanced
- 1.7 Volts Unbalanced

### Signal To Noise Ratio (A-Weighted)

- 95dB Balanced (120dB below rated output)
- 93dB Unbalanced (118dB below rated output)

### Intermodulation Distortion

0.005% maximum, if the instantaneous peak power output does not exceed twice the rated power output for any combination of frequencies from 20Hz to 20,000Hz.

### Wide Band Damping Factor

Greater than 40

### Input Impedance

- 22,000 ohms Balanced
- 22,000 ohms Unbalanced

### Voltage Gain

- 23dB, 2 Ohms
- 26dB, 4 Ohms
- 29dB, 8 Ohms

### Power Guard

Less than 2% Total Harmonic Distortion with up to a 14dB overdrive signal

### Power Control Input

5-15VDC, less than 1mA

### Power Control Output

12VDC, 50mA maximum  
Output is delayed 0.2 seconds from turn On

### Power Requirements

**Field AC Voltage conversion of the MC301 is not possible. The MC301 is factory configured for one of the following AC Voltages:**

- 100V ~ 50/60Hz at 4.4 Amps
- 110V ~ 50/60Hz at 3.7 Amps
- 120V ~ 50/60Hz at 3.7 Amps
- 220V ~ 50/60Hz at 2.0 Amps
- 230V ~ 50/60Hz at 1.9 Amps
- 240V ~ 50/60Hz at 1.9 Amps
- Standby: less than 0.3 watt

*Note: Refer to the rear panel of the MC301 for the correct voltage.*

### Overall Dimensions

Width is 17-1/2 inches (44.5cm)  
Height is 6 inches (15.2cm) including feet  
Depth is 21 inches (50.8cm) including the Front Panel and Cables

### Weight

67 pounds (30.4 kg) net, 77 pounds (34.9 kg) in shipping carton

### Shipping Carton Dimensions

Width is 27 inches (68.6cm)  
Height is 12-1/2 inches (31.8cm)  
Depth is 25 inches (63.5cm)

**Packing Instructions**

In the event it is necessary to repack the equipment for shipment, the equipment must be packed exactly as shown below. It is very important that the four plastic feet are attached to the bottom of the equipment. Two #10 x 2-1/4 inch screws and washers must be used to fasten the unit securely to the bottom pad and wood skid. This will ensure the proper equipment location on the bottom pad. Failure to do this will result in shipping damage.

Use the original shipping carton and interior parts only if they are all in good serviceable condition. If a shipping carton or any of the interior part(s) are needed, please call or write Customer Service Department of McIntosh Laboratory. Refer to page 3. Please see the Part List for the correct part numbers.

Quantity	Part Number	Description
1	03383600	Inner carton
1	03372500	Top pad
1	03430100	Bottom pad
1	03448000	Shipping skid
4	01793700	Foot
4	40015900	10-32 x 3/4 screw
4	40408000	#10 flat washer
1	03383800	Shipping carton
2	03383700	Foam Pad (end cap sides)
2	40120400	#10 x2-1/2 cap screw
2	40403300	#10 x 1-3/4 washer
2	01721800	Plastic foot spacer

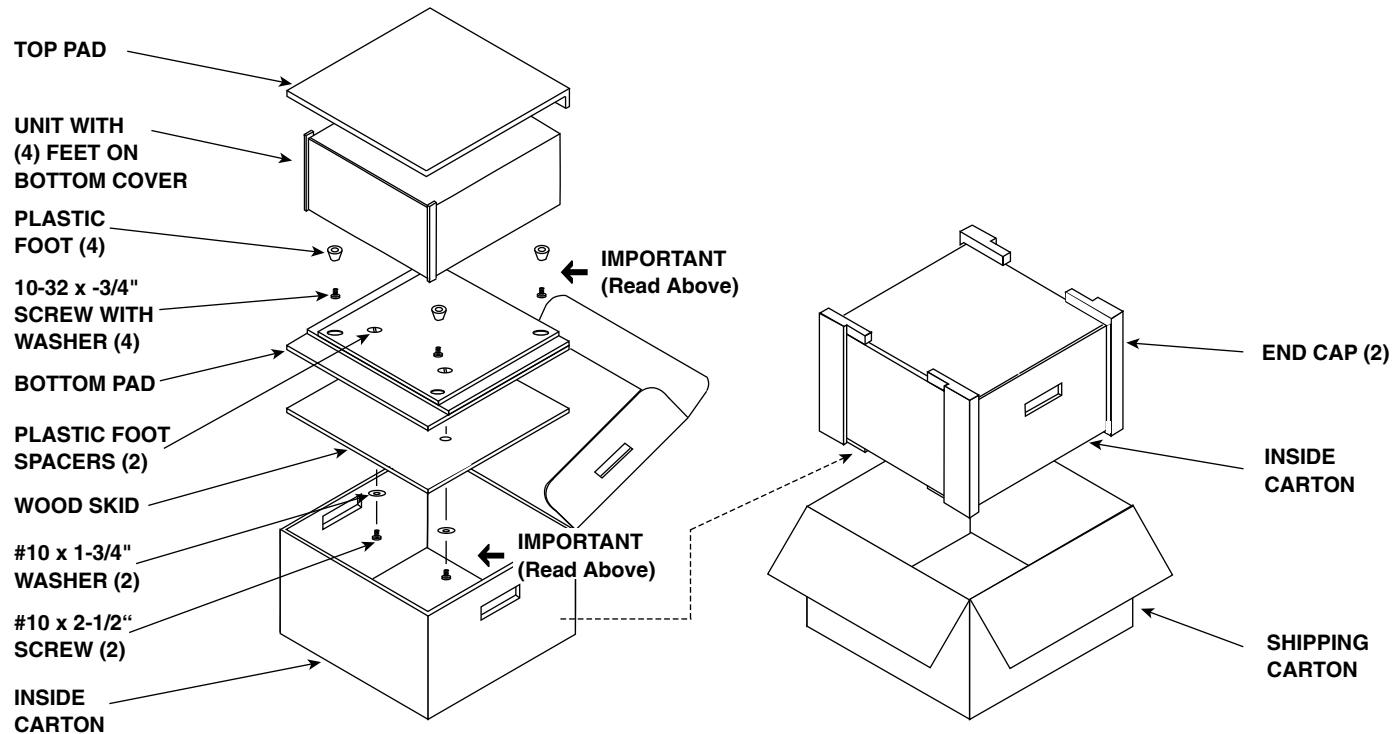



McIntosh Laboratory, Inc.  
2 Chambers Street  
Binghamton, NY 13903  
[www.mcintoshlabs.com](http://www.mcintoshlabs.com)

The continuous improvement of its products is the policy of McIntosh Laboratory Incorporated who reserve the right to improve design without notice.  
Printed in the U.S.A.